



LUMENSOURCE



HIGH BAY 150W ECONOMY SERIES

The LED High Bay uses only 150W compared to a 450W traditional metal halide light source. The flood light will have mounting bracket that can be screwed to any indoor or outdoor location that requires a high performance, energy saving, and long lasting light output.

SPECIFICATIONS

Wattage	150W
Voltage	120V AC
Average Lifetime	> 50,000 hrs
Colors	Warm White (3,000K) Cool White (5,000K)
Luminous Flux	13,330 lm (W); 14,000 lm (C)
Beam Angle	120 degrees
Dimensions	19.7"D x 15.3"H
LED	75

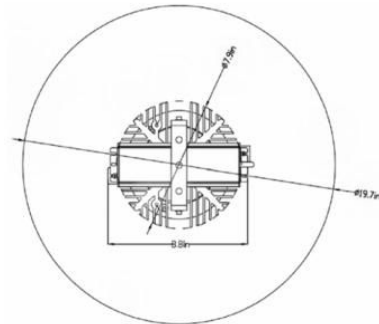
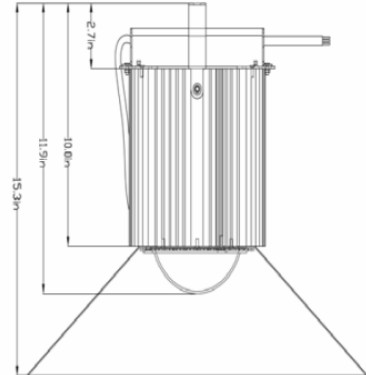

ORDERING INFO

- HBE-150-X
 - C – Cool White
 - W – Warm White

